



Fabbricatori del freddo mobile

Sin dal primo giorno della sua fondazione, in **Cold Car** si è cercato di dedicare ogni sforzo possibile alla cura della qualità e affidabilità del prodotto, per ottenere la massima soddisfazione del Cliente.

Questa può sembrare la solita affermazione, ma seguendo questi valori e partendo da una piccola località in Italia, sono stati raggiunti clienti in tutti e sei i continenti con rapporti stabili e duraturi nel tempo.

Le carrozzerie sono realizzate assemblando pannelli isotermitici sandwich strutturali, composti da un guscio esterno in materiale composito e un cuore in poliuretano espanso rigido controllato, verificato e certificato prima del suo utilizzo, per ottenere la massima uniformità dell'isolamento termico.

Gli impianti di refrigerazione sono ad accumulo eutettico, il gruppo frigorifero, ad alimentazione elettrica e funzionante solo in fase di sosta, congela la sostanza a cambiamento di fase negli evaporatori eutettici (accumulo di energia frigorifera) a -33°C , garantendo così una ideale temperatura di conservazione del prodotto durante l'intera giornata di distribuzione ed in qualunque condizione climatica. Inoltre il sistema ad accumulo garantisce: zero rumore in fase di consegna, zero consumo di carburante per il funzionamento del gruppo frigorifero ed è soprattutto idoneo, senza alcun tipo di modifica, per i veicoli alternativi e full Electric.

Le innovazioni continue hanno portato ad oggi risultati riconosciuti in termini di alte performance termodinamiche, bassi consumi elettrici e di conseguenza bassi costi di gestione, questo anche grazie a centraline elettroniche dedicate e sviluppate internamente.

Mobile cold manufacturers

Since the first day of its foundation, Cold Car has tried to devote every possible effort to the care of the quality and reliability of the product, to obtain maximum customer satisfaction.

This may seem like the usual statement, but by following these values and starting from a small town in Italy, customers have been reached on all six continents with stable and long-lasting relationships.

The bodies are made by assembling structural sandwich isothermal panels, made of an external shell in composite material and a core in controlled, verified and certified rigid pre-expanded polyurethane, to obtain maximum uniformity of thermal insulation.

The refrigeration systems are based on eutectic storage, the refrigeration unit, electrically powered and functioning only during the overnight stop, freezes the phase change substance in the eutectic evaporators (storage of cooling energy) at -33°C , thus guaranteeing an ideal storage temperature of the product during the whole day of distribution and in any climatic condition.

Furthermore, the accumulation system guarantees: zero noise during delivery, zero fuel consumption for the operation of the refrigeration unit and is above all suitable, without any type of modification, for alternative and full electric vehicles.

Continuous innovations have led to recognized results in terms of high thermodynamic performance, low electricity consumption and consequently low operating costs, also thanks to dedicated and internally developed electronic control units.





COLD CAR



Tipologia di categorie

Carrozzerie per tentata vendita

Carrozzerie con dimensioni esterne da 2 a 8 metri con carico e scarico del prodotto attraverso gli sportelli laterali.

Carrozzerie per pre vendita

Carrozzerie con dimensioni esterne da 3,5 a 8 metri con carico del prodotto dalla porta posteriore mediante roll containers e scarico attraverso gli sportelli laterali.

Carrozzerie multi temperatura

Carrozzerie con scomparti a temperature diverse adatte per distribuire prodotti congelati (-33°C), freschi (+4°C) o secchi (temperatura ambiente).

Gli scomparti sono ottenuti con paratie divisionali fisse o mobili.

Carrozzerie walk-in

Carrozzerie con accesso dalla porta posteriore con scaffalatura interna.

Il venditore entra a prelevare il prodotto.

Carrozzerie per consegna a domicilio

Carrozzerie multi temperatura per la consegna a domicilio della spesa effettuata online.

Tipologia di categorie

Refrigerated bodies for direct sales

Bodies with outer dimensions from 2 to 8 meters with loading and unloading the product through the side doors.

Refrigerated bodies for pre-sales

Bodies with outer dimensions from 3,5 to 8 meters with loading the product through the rear door with roll containers and unloading through the side doors.

Multi temperature bodies

Bodies with different temperatures suitable to distribute frozen products (-33°C), fresh products (+4°C) or dry products (ambient temperature).

The sections are designed using fixed or movable bulkheads to divide the merchandise.

Walk-in bodies

Bodies with access from the rear door with internal shelving. The seller is able to enter via the rear door and select product from custom shelving.

Bodies for home delivery

Multi temperature bodies for home delivery of online shopping sales.



Cold Car SpA
Sede Legale e Stabilimento:
Strada Paniate, 1 • 15040 Occimiano (AL) • Italy

Dir. +39 0142 400611 • Fax +39 0142 809456
info@coldcar.it • www.coldcar.it



**PIAGGIO
PORTER NP6
TW WB3250
SHORT RANGE LPG/CNG
LONG RANGE LPG
mod. 275 6SP BT N.1677**



DIMENSIONI ESTERNE
Outer dimension

mm 2750x1740x1200h

DIMENSIONI INTERNE
Inner dimension

mm 2550x1540x1000h

ISOLAMENTO/SPESSORE PANNELLI
Insulation

P.R.F.V. (poliestere rinforzato in fibra di vetro) autoportanti, ottenuti mediante stampaggio sotto pressa con l'impiego di poliuretano densità 35Kg/m³ e poliestere rinforzato con fibra di vetro. Spessore 100 mm
In expanded polyurethane with cycle pentane having density of 35 kg/m³ and covered by polyester resin reinforced with fibreglas. Wall thickness mm100

VOLUME INTERNO LORDO
Gross inner volume

3.9 m³

SPORTELLI
Side doors

N° 6 (3 dx - 3 sx) con apertura netta mm 550x900h
Nos. 6 (3 right - 3 left) of mm 550x900h

REFRIGERAZIONE
Refrigeration

Mediante piastre eutettiche con liquido a -33°C
By eutectic plates with solution at -33°C

GRUPPO FRIGORIFERO
Refrigerating unit

Installato nell'interasse lato dx con motocompressore semiermetico 2,5 HP. Gas refrigerante R452A
In outer position, under the body, in the right side of the wheelbase, equipped with semi-hermetic motor compressor 2,5 HP. Refrigerating gas R452A

OMOLOGAZIONE
Homologation

Carrozzeria in Classe RRC
Body with RRC homologation

PESO CARROZZERIA
Body weight

760 Kg +/- 3%

TABELLA CABINATI • CHASSIS CABS MODELS

MODELLO MODEL	PESO CARROZZERIA BODY WEIGH Kg	MTT GVW kg	PESO IN ODM Kg (TELAIO + CARROZZERIA) GVWR Kg (CHASSIS + BODY)	PORTATA RESIDUA PAYLOAD kg	LUNGHEZZA TOTALE TOTAL LENGTH
TW CHASSIS SHORT RANGE LPG	760	2520	1935	585	mm 4900
TW CHASSIS SHORT RANGE CNG	760	2520	1995	525	mm 4900
TW CHASSIS LONG RANGE LPG	930	2800	2135	665	mm 4900

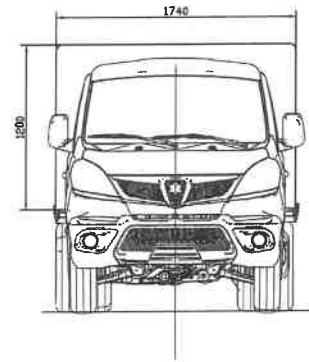
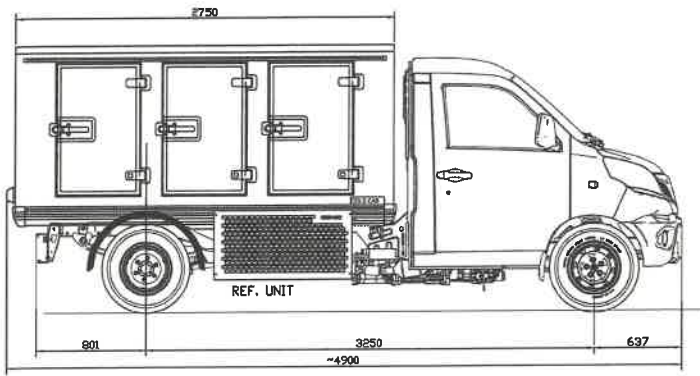

senso di marcia
moving way

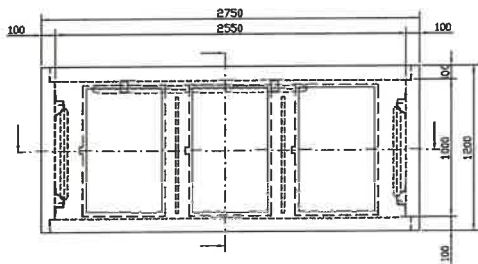

senso di marcia
moving way



PIASTRE EUTETTICHE
EUTECTIC PLATES

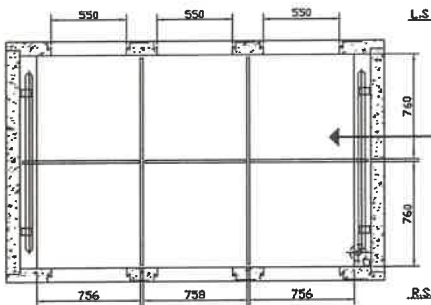
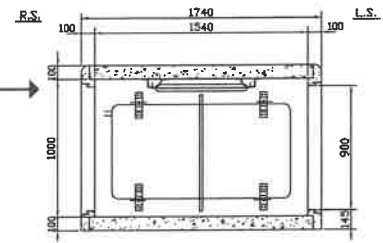

senso di marcia
moving way

GRIGLIE IN ALLUMINIO
ALUMINUM GRIDS



GRIGLIATO IN PLASTICA
PLASTIC GRATING



<input type="checkbox"/> 3CARS EVO Sistema di controllo temperatura Data monitoring system	<input type="checkbox"/> DECALCO Stickers
<input type="checkbox"/> GRUPPO REMOTO Remote refrigerating unit	<input type="checkbox"/> SENSORI DI PARCHEGGIO Rear parking sensors
<input type="checkbox"/> CHIUSURA CENTR. MANUALE Manual central locking system	<input type="checkbox"/> CESTELLO IN PLASTICA Plastic basket
<input type="checkbox"/> CHIUSURA CENTR. ELETTRICA Electrical central locking system	<input type="checkbox"/> TUBI IN ALLUMINIO AL2 Aluminum beams AL2
<input type="checkbox"/> RIPIANI IN ALLUMINIO Aluminum shelf	<input type="checkbox"/> TENDE IN PLASTICA Plastic curtains

NOTE

SERVIZIO • Delivery method

- TENTATA VENDITA
Direct sales
- PREVENDITA
Pre-order sales

ORE DI SERVIZIO • Delivery timing

- 10 h
- 12 h
- 14 h

RICARICA NOTTURNA • Night charge

- 14 h
- 12 h
- 10 h

CARICO PRODOTTI • Loading products

- SERA Evening
- MATTINA Morning

ALIMENTAZIONE • Power supply

- MONOFASE/1Ph V Hz
- TRIFASE/3Ph V Hz
- 4 POLI 3Ph+T
4 Pins 3Ph+G
- 5 POLI 3Ph+T+NEUTRO
5 Pins 3Ph+G+N



Cold Car SpA
Sede Legale e Stabilimento:
Strada Paniate, 1 • 15040 Occimiano (AL) • Italy

Dir. +39 0142 400611 • Fax +39 0142 809456
info@coldcar.it • www.coldcar.it



COLD CAR

**PIAGGIO
PORTER NP6
TW WB3250
SHORT RANGE LPG/CNG
LONG RANGE LPG
mod. 275 4SP 2T**

**DIMENSIONI ESTERNE***Outer dimension*

mm 2750x1740x1200h

DIMENSIONI INTERNE*Inner dimension*mm 1145x1740x1200h Scomparto anteriore - mm 1305x1740x1200h Scomparto posteriore
mm 1145x1740x1200h Front compartment - mm 1305x1740x1200h Rear compartment**ISOLAMENTO/SPESSORE PANNELLI***Insulation*P.R.F.V. (poliestere rinforzato in fibra di vetro) autoportanti, ottenuti mediante stampaggio sotto pressa con l'impiego di poliuretano densità 35Kg/m³ e poliestere rinforzato con fibra di vetro. Spessore 100 mm
In expanded polyurethane with cycle pentane having density of 35 kg/m³ and covered by polyester resin reinforced with fibreglas. Wall thickness mm100**VOLUME INTERNO LORDO***Gross inner volume*1,8 m³ Scomparto anteriore a -33°C - 1,8 m³ Scomparto posteriore a +2/+4°C
1,8 m³ Front compartment at -33°C - 1,8 m³ Rear compartment at +2/+4°C**SPORTELLI***Side doors*N° 4 (2 dx - 2 sx) con apertura netta mm 550x900h
Nos. 4 (2 right - 2 left) of mm 550x900h**REFRIGERAZIONE***Refrigeration*Mediante piastre eutettiche
By eutectic plates**GRUPPO FRIGORIFERO***Refrigerating unit*Installato nell'interasse lato dx con motocompressore semiermetico 2,5 HP. Gas refrigerante R452A
In outer position, under the body, in the right side of the wheelbase, equipped with semi-hermetic motor compressor 2,5 HP. Refrigerating gas R452A**OMOLOGAZIONE***Homologation*Carrozzeria in Classe RRC/RRA
Body with RRC/RRA homologation**PESO CARROZZERIA***Body weight*

760 Kg +/- 3%

TABELLA CABINATI • CHASSIS CABS MODELS

MODELLO MODEL	PESO CARROZZERIA BODY WEIGHT Kg	MTT GVW Kg	PESO IN ODM Kg (TELAIO + CARROZZERIA) GVWR Kg (CHASSIS + BODY)	PORTATA RESIDUA PAYLOAD Kg	LUNGHEZZA TOTALE TOTAL LENGTH
TW CHASSIS SHORT RANGE LPG	760	2520	1935	585	mm 4900
TW CHASSIS SHORT RANGE CNG	760	2520	1995	525	mm 4900
TW CHASSIS LONG RANGE LPG	930	2800	2135	665	mm 4900

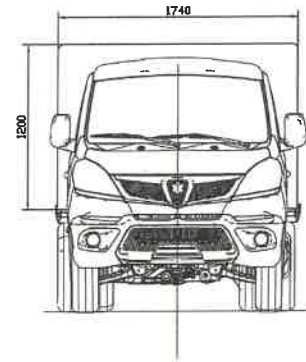
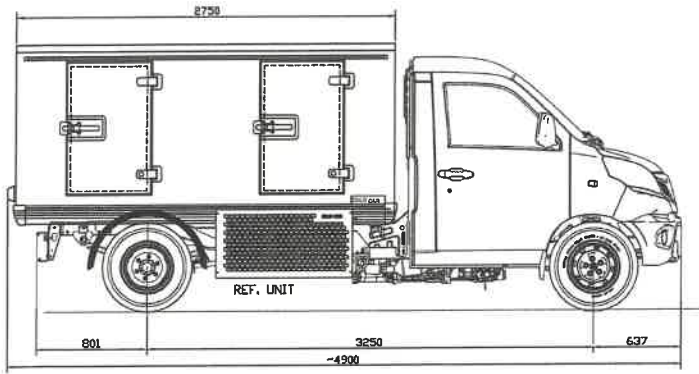

senso di marcia
moving way

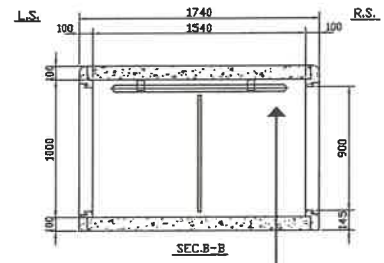
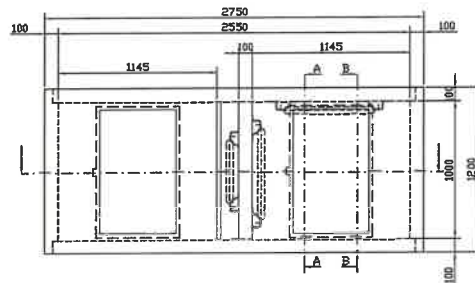
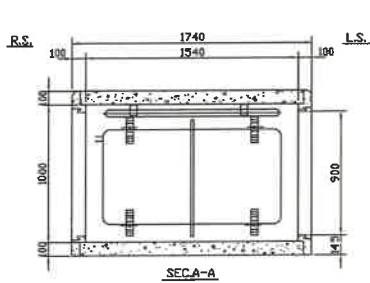

senso di marcia
moving way



PIASTRE EUTETTICHE
EUTECTIC PLATES

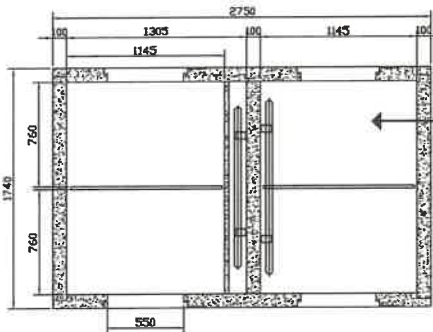

GRIGLIE IN ALLUMINIO
ALUMINUM GRIDS



GRIGLIATO IN PLASTICA
PLASTIC GRATING



senso di marcia
moving way

- | | |
|--|--|
| <input type="checkbox"/> 3CARS EVO
Sistema di controllo temperatura
Data monitoring system | <input type="checkbox"/> DECALCO
Stickers |
| <input type="checkbox"/> GRUPPO REMOTO
Remote refrigerating unit | <input type="checkbox"/> SENSORI DI PARCHEGGIO
Rear parking sensors |
| <input type="checkbox"/> CHIUSURA CENTR. MANUALE
Manual central locking system | <input type="checkbox"/> CESTELLO IN PLASTICA
Plastic basket |
| <input type="checkbox"/> CHIUSURA CENTR. ELETTRICA
Electrical central locking system | <input type="checkbox"/> TUBI IN ALLUMINIO AL2
Aluminum beams AL2 |
| <input type="checkbox"/> RIPIANI IN ALLUMINIO
Aluminum shelf | <input type="checkbox"/> TENDE IN PLASTICA
Plastic curtains |

NOTE

SERVIZIO • Delivery method

- | | |
|--|--|
| <input type="checkbox"/> TENTATA VENDITA
Direct sales | <input type="checkbox"/> PREVENDITA
Pre-order sales |
|--|--|

ORE DI SERVIZIO • Delivery timing

- | | | |
|-------------------------------|-------------------------------|-------------------------------|
| <input type="checkbox"/> 10 h | <input type="checkbox"/> 12 h | <input type="checkbox"/> 14 h |
|-------------------------------|-------------------------------|-------------------------------|

RICARICA NOTTURNA • Night charge

- | | | |
|-------------------------------|-------------------------------|-------------------------------|
| <input type="checkbox"/> 14 h | <input type="checkbox"/> 12 h | <input type="checkbox"/> 10 h |
|-------------------------------|-------------------------------|-------------------------------|

CARICO PRODOTTI • Loading products

- | | |
|---------------------------------------|--|
| <input type="checkbox"/> SERA Evening | <input type="checkbox"/> MATTINA Morning |
|---------------------------------------|--|

ALIMENTAZIONE • Power supply

- | | |
|--|--|
| <input type="checkbox"/> MONOFASE/1Ph V Hz | |
| <input type="checkbox"/> TRIFASE/3Ph V Hz | |
| <input type="checkbox"/> 4 POLI 3Ph+T
4 Pins 3Ph+G | <input type="checkbox"/> 5 POLI 3Ph+T+NEUTRO
5 Pins 3Ph+G+N |



Cold Car SpA
Sede Legale e Stabilimento:
Strada Paniate, 1 • 15040 Occimiano (AL) • Italy

Dir. +39 0142 400611 • Fax +39 0142 809456
info@coldcar.it • www.coldcar.it



COLD CAR

IVECO DAILY 35C
 passo 3000
 modello carrozzeria 310
 6SP BT N.1376

IVECO DAILY 35C
wb. 3000
mod. 310
6SP BT N.1376



DIMENSIONI ESTERNE
Outer dimension

mm 3100x2040x1550h

SPORTELLI LATERALI
Side doors

n. 6 (3 dx + 3 sx)
 n. 6 (3 right + 3 left)

VOLUME INTERNO LORDO
Gross inner volume

6,6 m³

IMPIANTO REFRIGERANTE
Refrigeration

n.4 piastre eutectiche con accumulo di 10520 Wh a -33°C
 by means of nos. 4 eutectic plates at -33°C having a total storage of 10520 Watts at -33°C

GRUPPO FRIGORIFERO
Refrigerating unit

esterno con motocompressore semiermetico a funzionamento automatico su termostato
 in outer position equipped with motorcompressor automatically working on thermostat

OMOLOGAZIONE
Homologation

Carrozzeria in Classe RRC
 Body with RRC homologation

PESO CARROZZERIA
Body weight

890 Kg



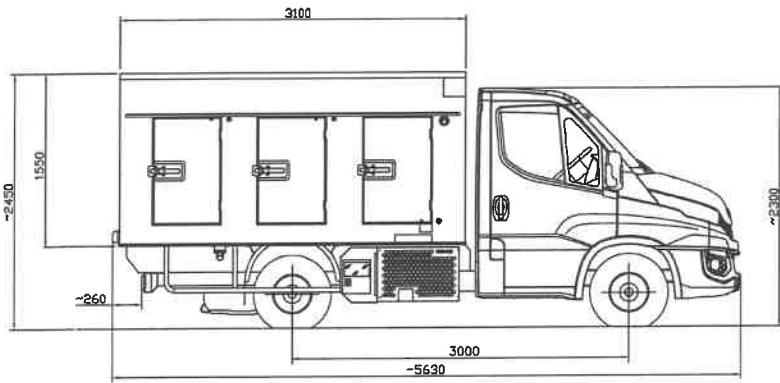

senso di marcia
moving way

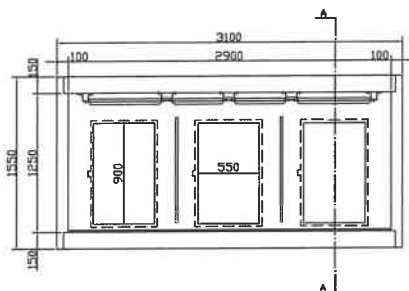
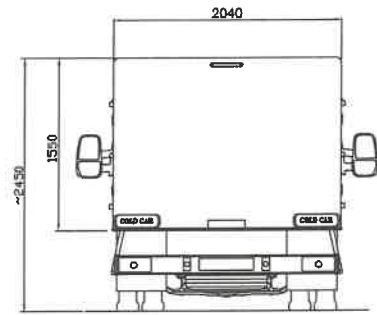

senso di marcia
moving way



PIASTRE EUTETTICHE
EUTECTIC PLATES

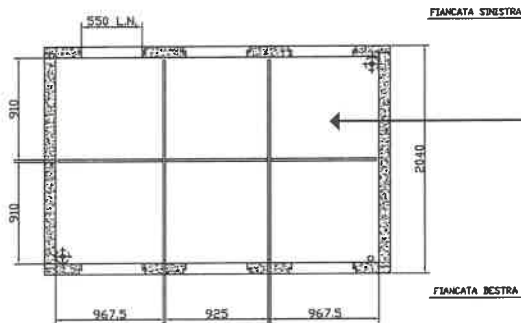
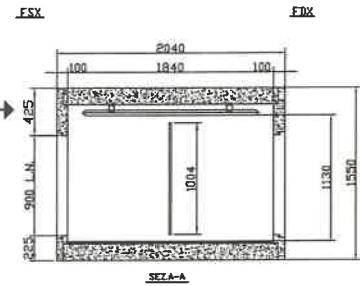

senso di marcia
moving way

GRIGLIE IN ALLUMINIO
ALUMINUM GRIDS



GRIGLIATO IN PLASTICA
PLASTIC GRATING



- | | |
|--|--|
| <input type="checkbox"/> 3CARS EVO
Sistema di controllo temperatura
Data monitoring system | <input type="checkbox"/> DECALCO
Stickers |
| <input type="checkbox"/> GRUPPO REMOTO
Remote refrigerating unit | <input type="checkbox"/> SENSORI DI PARCHEGGIO
Rear parking sensors |
| <input type="checkbox"/> CHIUSURA CENTR. MANUALE
Manual central locking system | <input type="checkbox"/> CESTELLO IN PLASTICA
Plastic basket |
| <input type="checkbox"/> CHIUSURA CENTR. ELETTRICA
Electrical central locking system | <input type="checkbox"/> TUBI IN ALLUMINIO AL2
Aluminum beams AL2 |
| <input type="checkbox"/> RIPIANI IN ALLUMINIO
Aluminum shelf | <input type="checkbox"/> TENDE IN PLASTICA
Plastic curtains |

NOTE

SERVIZIO • Delivery method

- | | |
|--|--|
| <input type="checkbox"/> TENTATA VENDITA
Direct sales | <input type="checkbox"/> PREVENDITA
Pre-order sales |
|--|--|

ORE DI SERVIZIO • Delivery timing

- | | | |
|-------------------------------|-------------------------------|-------------------------------|
| <input type="checkbox"/> 10 h | <input type="checkbox"/> 12 h | <input type="checkbox"/> 14 h |
|-------------------------------|-------------------------------|-------------------------------|

RICARICA NOTTURNA • Night charge

- | | | |
|-------------------------------|-------------------------------|-------------------------------|
| <input type="checkbox"/> 14 h | <input type="checkbox"/> 12 h | <input type="checkbox"/> 10 h |
|-------------------------------|-------------------------------|-------------------------------|

CARICO PRODOTTI • Loading products

- | | |
|---------------------------------------|--|
| <input type="checkbox"/> SERA Evening | <input type="checkbox"/> MATTINA Morning |
|---------------------------------------|--|

ALIMENTAZIONE • Power supply

- | | |
|--|--|
| <input type="checkbox"/> MONOFASE/1Ph V Hz | |
| <input type="checkbox"/> TRIFASE/3Ph V Hz | |
| <input type="checkbox"/> 4 POLI 3Ph+T
4 Pins 3Ph+G | <input type="checkbox"/> 5 POLI 3Ph+T+NEUTRO
5 Pins 3Ph+G+N |



Cold Car SpA
Sede Legale e Stabilimento:
Strada Paniate, 1 • 15040 Occimiano (AL) • Italy

Dir. +39 0142 400611 • Fax +39 0142 809456
info@coldcar.it • www.coldcar.it



COLD CAR

IVECO DAILY 35C/S
 passo 3450
 modello carrozzeria 360
 8SP BT N.1034

IVECO DAILY 35C/S
wb. 3450
mod. 360
8SP BT N.1034



DIMENSIONI ESTERNE
Outer dimension

mm 3600x2040x1550h

SPORTELLI LATERALI
Side doors

n. 8 (4 dx + 4 sx)
 n. 8 (4 right + 4 left)

VOLUME INTERNO LORDO
Gross inner volume

7,8 m³

IMPIANTO REFRIGERANTE
Refrigeration

n.5 piastre eutectiche con accumulo di 8650 Wh a -33°C
 by means of nos. 5 eutectic plates at -33°C having a total storage of 8650 Watts at -33°C

GRUPPO FRIGORIFERO
Refrigerating unit

esterno con motocompressore semiermetico a funzionamento automatico su termostato
 in outer position equipped with motorcompressor automatically working on thermostat

OMOLOGAZIONE
Homologation

Carrozzeria in Classe RRC
 Body with RRC homologation

PESO CARROZZERIA
Body weight

960 Kg



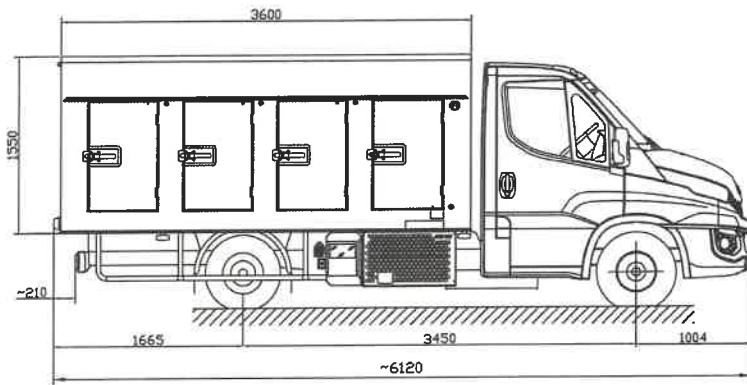

sensò di marcia
moving way

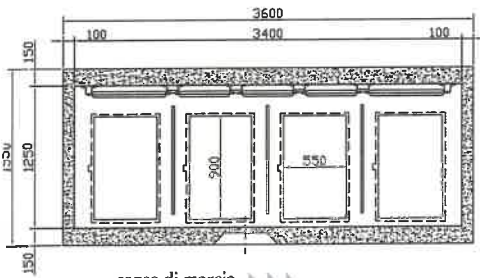
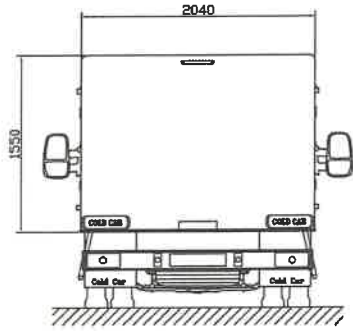

sensò di marcia
moving way



PIASTRE EUTETTICHE
EUTECTIC PLATES

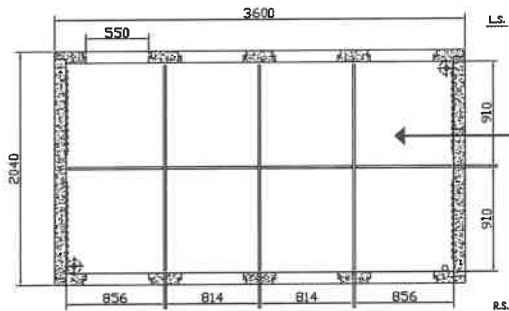
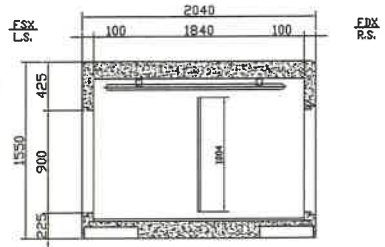

sensò di marcia
moving way

GRIGLIE IN ALLUMINIO
ALUMINUM GRIDS



GRIGLIATO IN PLASTICA
PLASTIC GRATING



<input type="checkbox"/> 3CARS EVO Sistema di controllo temperatura Data monitoring system	<input type="checkbox"/> DECALCO Stickers
<input type="checkbox"/> GRUPPO REMOTO Remote refrigerating unit	<input type="checkbox"/> SENSORI DI PARCHEGGIO Rear parking sensors
<input type="checkbox"/> CHIUSURA CENTR. MANUALE Manual central locking system	<input type="checkbox"/> CESTELLO IN PLASTICA Plastic basket
<input type="checkbox"/> CHIUSURA CENTR. ELETTRICA Electrical central locking system	<input type="checkbox"/> TUBI IN ALLUMINIO AL2 Aluminum beams AL2
<input type="checkbox"/> RIPIANI IN ALLUMINIO Aluminum shelf	<input type="checkbox"/> TENDE IN PLASTICA Plastic curtains

NOTE

SERVIZIO • Delivery method

- TENTATA VENDITA
Direct sales
- PREVENDITA
Pre-order sales

ORE DI SERVIZIO • Delivery timing

- 10 h 12 h 14 h

RICARICA NOTTURNA • Night charge

- 14 h 12 h 10 h

CARICO PRODOTTI • Loading products

- SERA Evening MATTINA Morning

ALIMENTAZIONE • Power supply

- MONOFASE/1Ph V Hz
- TRIFASE/3Ph V Hz
- 4 POLI 3Ph+T 5 POLI 3Ph+T+NEUTRO
4 Pins 3Ph+G 5 Pins 3Ph+G+N



Cold Car SpA
Sede Legale e Stabilimento:
Strada Paniate, 1 • 15040 Occimiano (AL) • Italy

Dir. +39 0142 400611 • Fax +39 0142 809456
info@coldcar.it • www.coldcar.it



IVECO DAILY 35C/S
 passo 3450
 modello carrozzeria 380
 8SP BT N.1660

IVECO DAILY 35C/S
wb. 3450
mod. 380
8SP BT N.1660



DIMENSIONI ESTERNE
Outer dimension

mm 3800x2100x1700h

SPORTELLI LATERALI
Side doors

n. 8 (4 dx + 4 sx)
 n. 8 (4 right + 4 left)

VOLUME INTERNO LORDO
Gross inner volume

9,5 m³

IMPIANTO REFRIGERANTE
Refrigeration

n.5 piastre eutectiche con accumulo di 11600 Wh a -33°C
 by means of nos. 5 eutectic plates at -33°C having a total storage of 11600 Watts at -33°C

GRUPPO FRIGORIFERO
Refrigerating unit

esterno con motocompressore semiermetico a funzionamento automatico su termostato
 in outer position equipped with motorcompressor automatically working on thermostat

OMOLOGAZIONE
Homologation

Carrozzeria in Classe RRC
 Body with RRC homologation

PESO CARROZZERIA
Body weight

1100 Kg



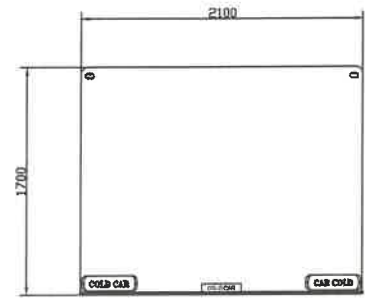
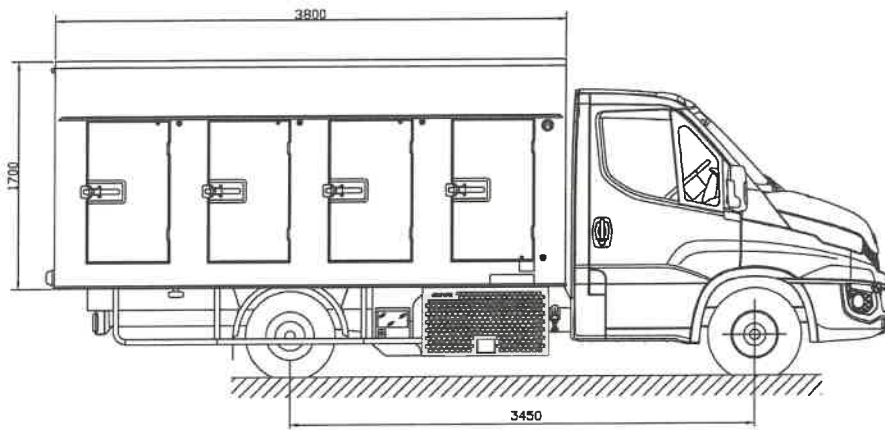

senso di marcia
moving way

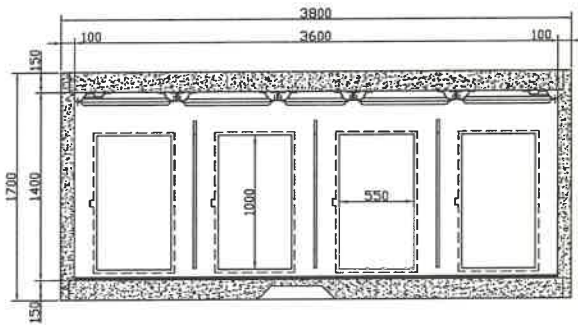

senso di marcia
moving way



PIASTRE EUTETTICHE
EUTECTIC PLATES

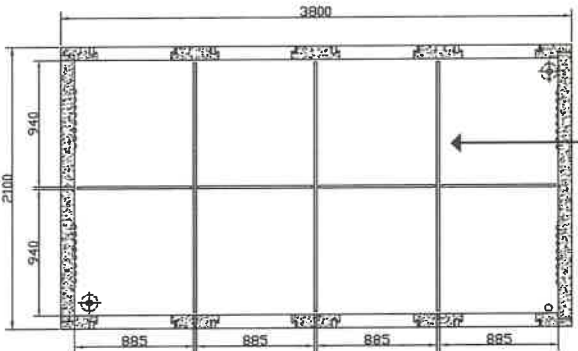
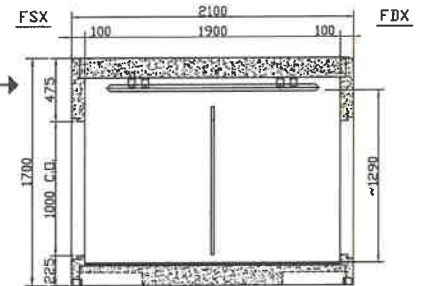

senso di marcia
moving way

GRIGLIE IN ALLUMINIO
ALUMINUM GRIDS



GRIGLIATO IN PLASTICA
PLASTIC GRATING



- | | |
|--|--|
| <input type="checkbox"/> 3CARS EVO
Sistema di controllo temperatura
Data monitoring system | <input type="checkbox"/> DECALCO
Stickers |
| <input type="checkbox"/> GRUPPO REMOTO
Remote refrigerating unit | <input type="checkbox"/> SENSORI DI PARCHEGGIO
Rear parking sensors |
| <input type="checkbox"/> CHIUSURA CENTR. MANUALE
Manual central locking system | <input type="checkbox"/> CESTELLO IN PLASTICA
Plastic basket |
| <input type="checkbox"/> CHIUSURA CENTR. ELETTRICA
Electrical central locking system | <input type="checkbox"/> TUBI IN ALLUMINIO AL2
Aluminum beams AL2 |
| <input type="checkbox"/> RIPIANI IN ALLUMINIO
Aluminum shelf | <input type="checkbox"/> TENDE IN PLASTICA
Plastic curtains |

NOTE

SERVIZIO • Delivery method

- | | |
|--|--|
| <input type="checkbox"/> TENTATA VENDITA
Direct sales | <input type="checkbox"/> PREVENDITA
Pre-order sales |
|--|--|

ORE DI SERVIZIO • Delivery timing

- | | | |
|-------------------------------|-------------------------------|-------------------------------|
| <input type="checkbox"/> 10 h | <input type="checkbox"/> 12 h | <input type="checkbox"/> 14 h |
|-------------------------------|-------------------------------|-------------------------------|

RICARICA NOTTURNA • Night charge

- | | | |
|-------------------------------|-------------------------------|-------------------------------|
| <input type="checkbox"/> 14 h | <input type="checkbox"/> 12 h | <input type="checkbox"/> 10 h |
|-------------------------------|-------------------------------|-------------------------------|

CARICO PRODOTTI • Loading products

- | | |
|---------------------------------------|--|
| <input type="checkbox"/> SERA Evening | <input type="checkbox"/> MATTINA Morning |
|---------------------------------------|--|

ALIMENTAZIONE • Power supply

- | | |
|--|--|
| <input type="checkbox"/> MONOFASE/1Ph V Hz | |
| <input type="checkbox"/> TRIFASE/3Ph V Hz | |
| <input type="checkbox"/> 4 POLI 3Ph+T
4 Pins 3Ph+G | <input type="checkbox"/> 5 POLI 3Ph+T+NEUTRO
5 Pins 3Ph+G+N |



Cold Car SpA
Sede Legale e Stabilimento:
Strada Paniate, 1 • 15040 Occimiano (AL) • Italy

Dir. +39 0142 400611 • Fax +39 0142 809456
info@coldcar.it • www.coldcar.it



COLD CAR

IVECO DAILY 35C/S
 passo 3750
 modello carrozzeria 420
 8SP BT GS N.1035

IVECO DAILY 35C/S
 wb. 3750
 mod. 420
 8SP BT GS N.1035



DIMENSIONI ESTERNE
Outer dimension

mm 4200x2040x1700h

SPORTELLI LATERALI
Side doors

n. 8 (4 dx + 4 sx)
 n. 8 (4 right + 4 left)

VOLUME INTERNO LORDO
Gross inner volume

10 m³

IMPIANTO REFRIGERANTE
Refrigeration

n.5 piastre eutectiche con accumulo di 13300 Wh a -33°C
 by means of nos. 5 eutectic plates at -33°C having a total storage of 13300 Watts at -33°C

GRUPPO FRIGORIFERO
Refrigerating unit

esterno con motorecompressore semiermetico a funzionamento automatico su termostato
 in outer position equipped with motorcompressor automatically working on thermostat

OMOLOGAZIONE
Homologation

Carrozzeria in Classe RRC
 Body with RRC homologation

PESO CARROZZERIA
Body weight

1120 Kg



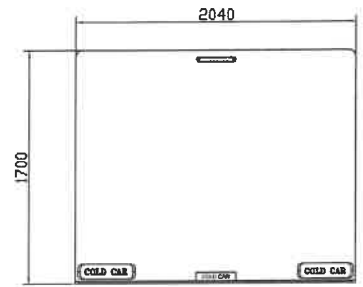
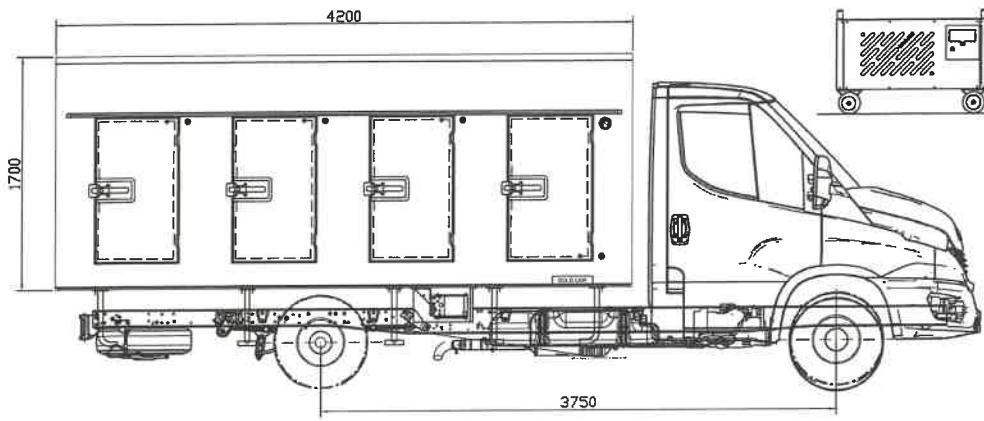

senso di marcia
moving way

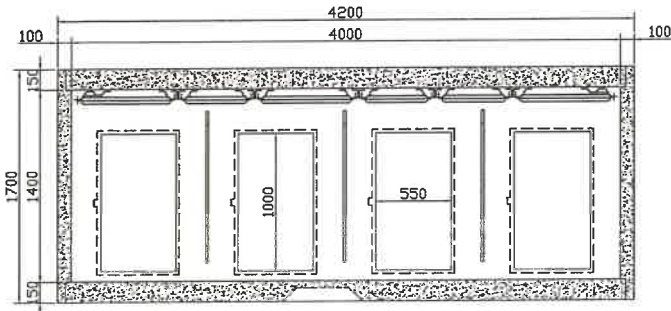

senso di marcia
moving way



PIASTRE EUTETTICHE
EUTECTIC PLATES

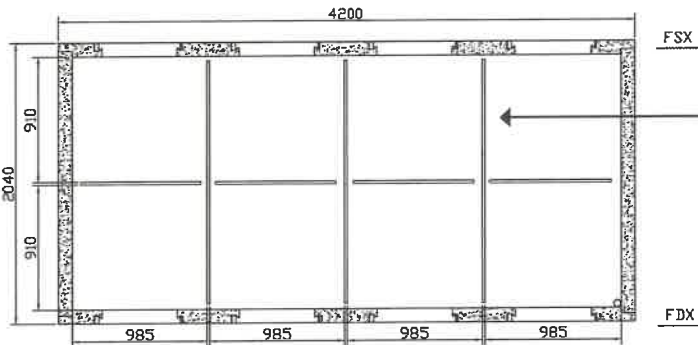
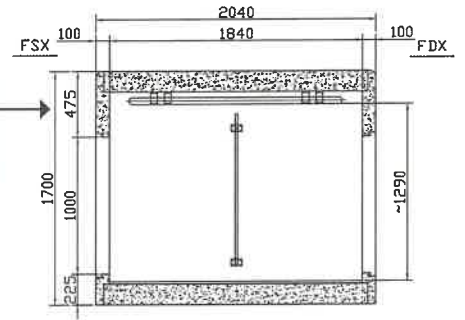

senso di marcia
moving way

GRIGLIE IN ALLUMINIO
ALUMINUM GRIDS



GRIGLIATO IN PLASTICA
PLASTIC GRATING



- | | |
|--|--|
| <input type="checkbox"/> 3CARS EVO
Sistema di controllo temperatura
Data monitoring system | <input type="checkbox"/> DECALCO
Stickers |
| <input type="checkbox"/> GRUPPO REMOTO
Remote refrigerating unit | <input type="checkbox"/> SENSORI DI PARCHEGGIO
Rear parking sensors |
| <input type="checkbox"/> CHIUSURA CENTR. MANUALE
Manual central locking system | <input type="checkbox"/> CESTELLO IN PLASTICA
Plastic basket |
| <input type="checkbox"/> CHIUSURA CENTR. ELETTRICA
Electrical central locking system | <input type="checkbox"/> TUBI IN ALLUMINIO AL2
Aluminum beams AL2 |
| <input type="checkbox"/> RIPIANI IN ALLUMINIO
Aluminum shelf | <input type="checkbox"/> TENDE IN PLASTICA
Plastic curtains |

NOTE

SERVIZIO • Delivery method

- | | |
|--|--|
| <input type="checkbox"/> TENTATA VENDITA
Direct sales | <input type="checkbox"/> PREVENDITA
Pre-order sales |
|--|--|

ORE DI SERVIZIO • Delivery timing

- | | | |
|-------------------------------|-------------------------------|-------------------------------|
| <input type="checkbox"/> 10 h | <input type="checkbox"/> 12 h | <input type="checkbox"/> 14 h |
|-------------------------------|-------------------------------|-------------------------------|

RICARICA NOTTURNA • Night charge

- | | | |
|-------------------------------|-------------------------------|-------------------------------|
| <input type="checkbox"/> 14 h | <input type="checkbox"/> 12 h | <input type="checkbox"/> 10 h |
|-------------------------------|-------------------------------|-------------------------------|

CARICO PRODOTTI • Loading products

- | | |
|---------------------------------------|--|
| <input type="checkbox"/> SERA Evening | <input type="checkbox"/> MATTINA Morning |
|---------------------------------------|--|

ALIMENTAZIONE • Power supply

- | | |
|--|--|
| <input type="checkbox"/> MONOFASE/1Ph V Hz | |
| <input type="checkbox"/> TRIFASE/3Ph V Hz | |
| <input type="checkbox"/> 4 POLI 3Ph+T
4 Pins 3Ph+G | <input type="checkbox"/> 5 POLI 3Ph+T+NEUTRO
5 Pins 3Ph+G+N |



Cold Car SpA
Sede Legale e Stabilimento:
Strada Paniate, 1 • 15040 Occimiano (AL) • Italy

Dir. +39 0142 400611 • Fax +39 0142 809456
info@coldcar.it • www.coldcar.it



COLD CAR

IVECO EUROCARGO
 passo 3105
 modello carrozzeria 438
 8SP BT N.928

IVECO EUROCARGO
 wb. 3105
 mod. 438
 8SP BT N.928



DIMENSIONI ESTERNE
Outer dimension

mm 4380x2300x1700h

SPORTELLI LATERALI
Side doors

n. 8 (4 dx + 4 sx)
 n. 8 (4 right + 4 left)

VOLUME INTERNO LORDO
Gross inner volume

13,1 m³

IMPIANTO REFRIGERANTE
Refrigeration

n.6 piastre eutectiche con accumulo di 17000 Wh a -33°C
 by means of nos. 6 eutectic plates at -33°C having a total storage of 17000 Watts at -33°C

GRUPPO FRIGORIFERO
Refrigerating unit

esterno con motocompressore semiermetico a funzionamento automatico su termostato
 in outer position equipped with motorcompressor automatically working on thermostat

OMOLOGAZIONE
Homologation

Carrozzeria in Classe RRC
 Body with RRC homologation

PESO CARROZZERIA
Body weight

1640 Kg



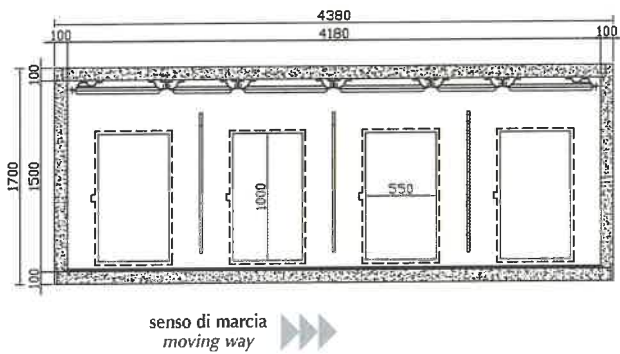
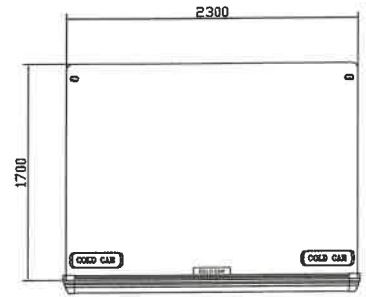
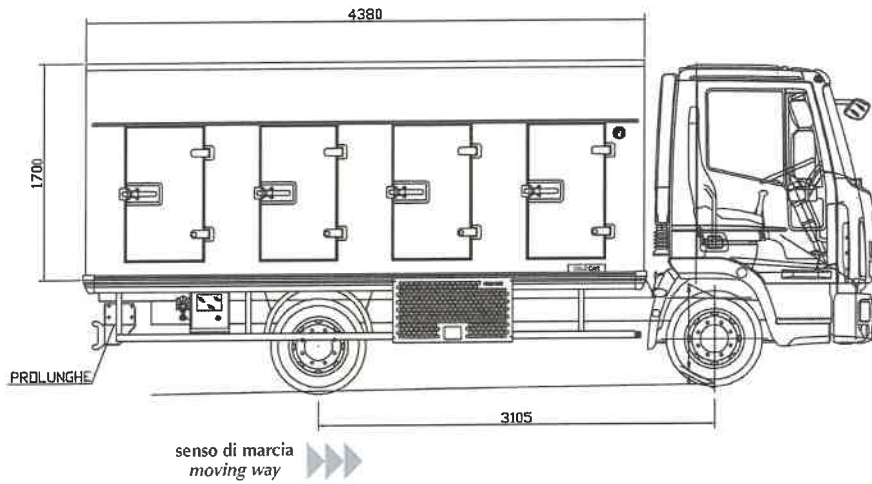

PIASTRE EUTETTICHE
EUTECTIC PLATES

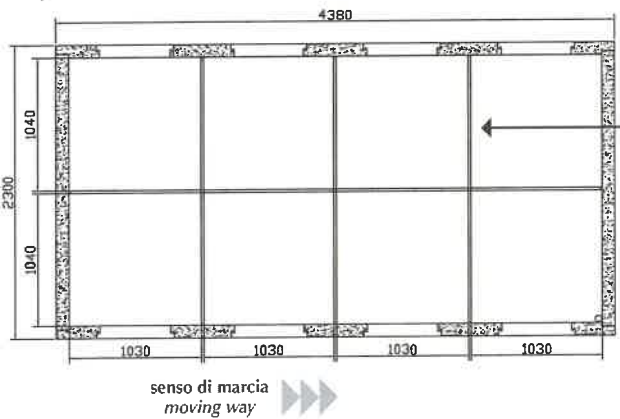
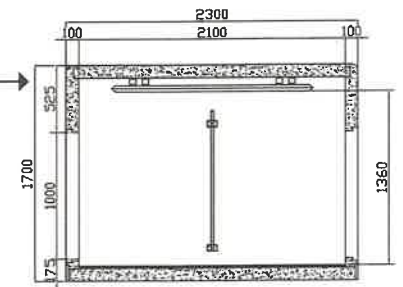

GRIGLIE IN ALLUMINIO
ALUMINUM GRIDS



GRIGLIATO IN PLASTICA
PLASTIC GRATING



- | | |
|--|--|
| <input type="checkbox"/> 3CARS EVO
Sistema di controllo temperatura
Data monitoring system | <input type="checkbox"/> DECALCO
Stickers |
| <input type="checkbox"/> GRUPPO REMOTO
Remote refrigerating unit | <input type="checkbox"/> SENSORI DI PARCHEGGIO
Rear parking sensors |
| <input type="checkbox"/> CHIUSURA CENTR. MANUALE
Manual central locking system | <input type="checkbox"/> CESTELLO IN PLASTICA
Plastic basket |
| <input type="checkbox"/> CHIUSURA CENTR. ELETTRICA
Electrical central locking system | <input type="checkbox"/> TUBI IN ALLUMINIO AL2
Aluminum beams AL2 |
| <input type="checkbox"/> RIPIANI IN ALLUMINIO
Aluminum shelf | <input type="checkbox"/> TENDE IN PLASTICA
Plastic curtains |

NOTE

SERVIZIO • Delivery method

- | | |
|--|--|
| <input type="checkbox"/> TENTATA VENDITA
Direct sales | <input type="checkbox"/> PREVENDITA
Pre-order sales |
|--|--|

ORE DI SERVIZIO • Delivery timing

- | | | |
|-------------------------------|-------------------------------|-------------------------------|
| <input type="checkbox"/> 10 h | <input type="checkbox"/> 12 h | <input type="checkbox"/> 14 h |
|-------------------------------|-------------------------------|-------------------------------|

RICARICA NOTTURNA • Night charge

- | | | |
|-------------------------------|-------------------------------|-------------------------------|
| <input type="checkbox"/> 14 h | <input type="checkbox"/> 12 h | <input type="checkbox"/> 10 h |
|-------------------------------|-------------------------------|-------------------------------|

CARICO PRODOTTI • Loading products

- | | |
|---------------------------------------|--|
| <input type="checkbox"/> SERA Evening | <input type="checkbox"/> MATTINA Morning |
|---------------------------------------|--|

ALIMENTAZIONE • Power supply

- | | |
|--|--|
| <input type="checkbox"/> MONOFASE/1Ph V Hz | |
| <input type="checkbox"/> TRIFASE/3Ph V Hz | |
| <input type="checkbox"/> 4 POLI 3Ph+T
4 Pins 3Ph+G | <input type="checkbox"/> 5 POLI 3Ph+T+NEUTRO
5 Pins 3Ph+G+N |



Cold Car SpA
Sede Legale e Stabilimento:
Strada Paniate, 1 • 15040 Occimiano (AL) • Italy

Dir. +39 0142 400611 • Fax +39 0142 809456
info@coldcar.it • www.coldcar.it



IVECO EUROCARGO
 passo 3690
 modello carrozzeria 525
 10SP PP 2T N.1260

IVECO EUROCARGO
 wb. 3690
 mod. 525
 10SP PP 2T N.1260



La carrozzeria multi temperatura è la soluzione che Cold Car ha presentato alla clientela che necessita di avere diverse temperature controllate per diverse tipologie di merci da trasportare con un solo veicolo. Ecco allora che possiamo avere un allestimento con uno scomparto a bassa temperatura a -33°C per il trasporto di gelati e/o alimenti surgelati, uno scomparto a temperatura positiva di $+2/+5^{\circ}\text{C}$ per il trasporto di alimenti freschi e/o latticini oppure uno scomparto isotermico senza refrigerazione per alimenti secchi. Ovviamente la refrigerazione è sempre ottenuta mediante piastre eutectiche ad accumulo, assicurando così la temperatura d'esercizio per tutta la durata del servizio di distribuzione.

The multi-temperature body is the study that Cold Car has introduced to the customers that require different controlled temperatures for different products to deliver with only one vehicle. We can have a body with a low temperature compartment at -33°C suitable for ice-cream and/or frozen foods transportation, one with medium temperature at $+2/+5^{\circ}\text{C}$ for fresh products and dairy or an isothermal compartment without refrigeration for dry products. Obviously the refrigeration is obtained with eutectic plates that store the cold, assuring in such way the correct temperature for the whole distribution service.



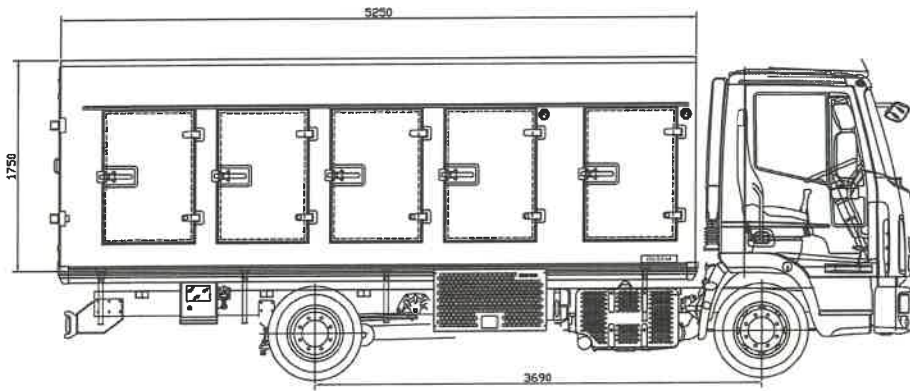

sensu di marcia
moving way

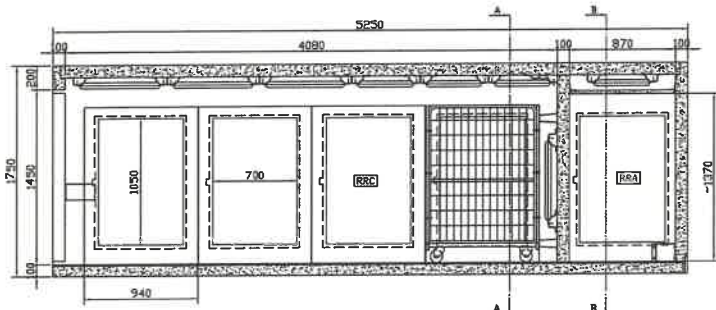

sensu di marcia
moving way

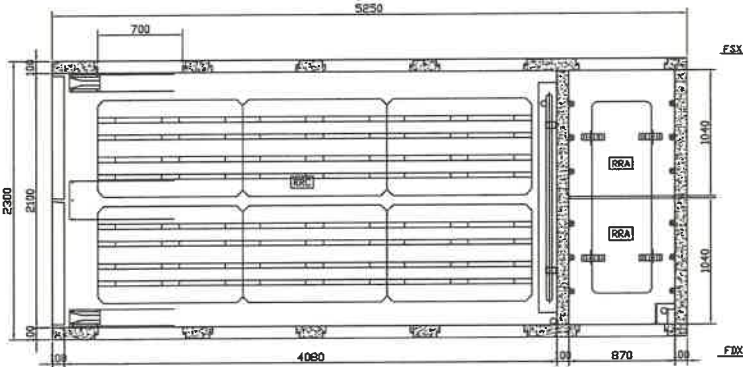

sensu di marcia
moving way

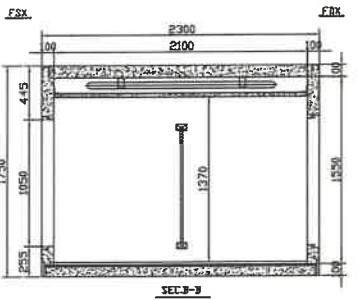
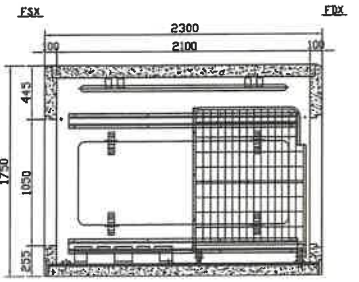
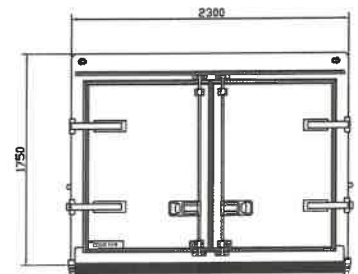

PIASTRE EUTETTICHE
EUTECTIC PLATES



GRIGLIE IN ALLUMINIO
ALUMINUM GRIDS

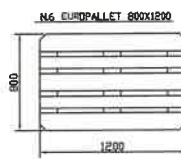
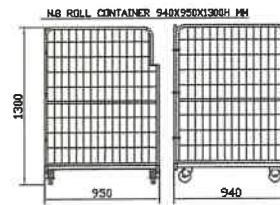

GRIGLIATO IN PLASTICA
PLASTIC GRATING



SERVIZIO • Delivery method

- TENTATA VENDITA
Direct sales
- PREVENDITA
Pre-order sales

ORE DI SERVIZIO • Delivery timing

- 10 h
- 12 h
- 14 h

RICARICA NOTTURNA • Night charge

- 14 h
- 12 h
- 10 h

CARICO PRODOTTI • Loading products

- SERA Evening
- MATTINA Morning

ALIMENTAZIONE • Power supply

- MONOFASE/1Ph V Hz
- TRIFASE/3Ph V Hz
- 4 POLI 3Ph+T
4 Pins 3Ph+G
- 5 POLI 3Ph+T+NEUTRO
5 Pins 3Ph+G+N

- 3CARS EVO
Sistema di controllo temperatura
Data monitoring system
- GRUPPO REMOTO
Remote refrigerating unit
- CHIUSURA CENTR. MANUALE
Manual central locking system
- CHIUSURA CENTR. ELETTRICA
Electrical central locking system
- RIPIANTI IN ALLUMINIO
Aluminum shelf
- DECALCO
Stickers
- SENSORI DI PARCHEGGIO
Rear parking sensors
- CESTELLO IN PLASTICA
Plastic basket
- TUBI IN ALLUMINIO AL2
Aluminum beams AL2
- TENDE IN PLASTICA
Plastic curtains

NOTE



Cold Car SpA
Sede Legale e Stabilimento:
Strada Paniate, 1 • 15040 Occimiano (AL) • Italy

Dir. +39 0142 400611 • Fax +39 0142 809456
info@coldcar.it • www.coldcar.it



ACCESSORI SU RICHIESTA

ACCESSORIES ON REQUEST



Gruppo remoto con innesto rapido.
Remote refrigerating unit with fast coupling system.



Chiusura centralizzata manuale degli sportelli.
Manual central locking system of the side doors.



Chiusura centralizzata elettronica degli sportelli con telecomando.
Electronic central locking system of the side doors by remote control.



Roll containers in acciaio zincato con un ripiano.
Galvanized steel roll containers with one adjustable shelf.



Ripiano in alluminio anodizzato.
Anodized aluminum shelf.

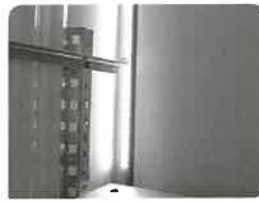

Lampade a led.
Led lights.



Ripiano in bacchette di alluminio regolabile in altezza.
Roads aluminum shelf adjustable in height.



Tenda parafreddo in plastica.
Plastic curtain for cold retention.



Cestello pieghevole sotto gli sportelli.
Foldable basket under the side doors.



Grafiche personalizzate con applicazione di decalcomanie.
Custom made graphics with application of stickers.



